

XENSIV™ PAS CO2

Description

Infineon has leveraged its knowledge in sensors and MEMS technologies to develop a disruptive gas sensor for CO₂ sensing. The XENSIV™ PAS CO₂ is a real CO₂ sensor in an exceptionally small form factor based on the photoacoustic spectroscopy (PAS) principle.

Infineon's MEMS microphone, which is optimized for low-frequency operation, detects the pressure change generated by CO₂ molecules within the sensor cavity. CO₂ concentration is then delivered in the form of a direct ppm readout thanks to the integrated microcontroller. Highly accurate CO₂ readings are guaranteed since the absorption chamber is acoustically isolated from external noise.



Features

- **Operating range:** 0 ppm to 10000 ppm
- **Accuracy:** ± (30 ppm +3%) of reading between 400 ppm and 5000 ppm
- **Lifetime:** 10 years at 1 measurement/minute
- **Operating temperature:** 0-50°C
- **Operating relative humidity:** 0% to 85% (Non-condensing)
- **Interface:** I2C, UART, and PWM
- **Supply voltage:** 12.0 V for the emitter and 3.3 V for other components
- **Average power consumption:** Typically, 30 mW at 1 measurement/minute
- **Package dimension:** 13.8 x 14 x 7.5 mm³

Potential applications

High accuracy, compact size, and SMD capability make the XENSIV™ PAS CO₂ sensor ideal for indoor air quality monitoring solutions in the market with numerous potential applications.

- **Building automation:** Demand Controlled Ventilation, Air Handler Units, Air Exchanger
- **Home appliances:** Air purifiers, Air Conditioner
- **Smart home IoT devices:** Thermostat, Speaker, Baby monitors, Personal assistants, Indoor Air Quality Monitor, Smart lighting.
- **City management/ CO₂ emissions control:** Outdoor lighting, Bus stop stations, Advertising billboards.
- **In-cabin air quality monitoring unit**

Product validation

Technology qualified for industrial applications.

Table of contents

Description	1
Features	1
Potential applications	1
Product validation	1
Table of contents	2
1 Block diagram.....	3
2 Pin-out diagram	4
3 The typical sensor response to the CO₂ concentration change	5
4 Characteristics and parameters	6
4.1 Specification.....	6
4.1.1 Operating range	6
4.1.2 Timing characteristics.....	6
4.1.3 Absolute maximum ratings.....	8
4.1.4 The current rating and power consumption.....	8
4.1.5 CO ₂ Transfer Function	9
4.1.6 Peripheral timing	10
4.1.6.1 I2C Timing.....	10
4.2 Application Circuit Example.....	11
4.3 Functional description	11
4.3.1 Operating Modes.....	11
4.3.2 Data post-processing	12
4.3.3 Alarm Threshold.....	13
4.4 Advanced functionality	13
4.5 Digital interface	14
4.5.1 I2C interface	14
4.5.2 I2C transaction format	14
4.5.3 UART Interface.....	15
4.6 Register map.....	15
5 Package information	16
6 Packing for shipment.....	17
7 Revision history	18

1 Block diagram

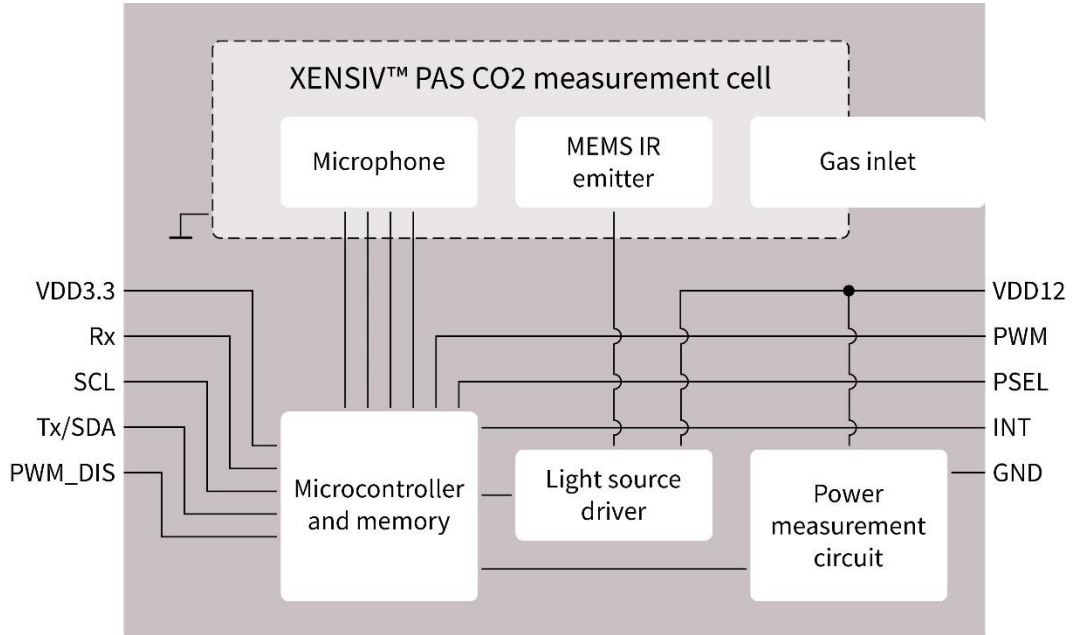

Figure 1 Block diagram of XENSIV™ PAS CO2

2 Pin-out diagram

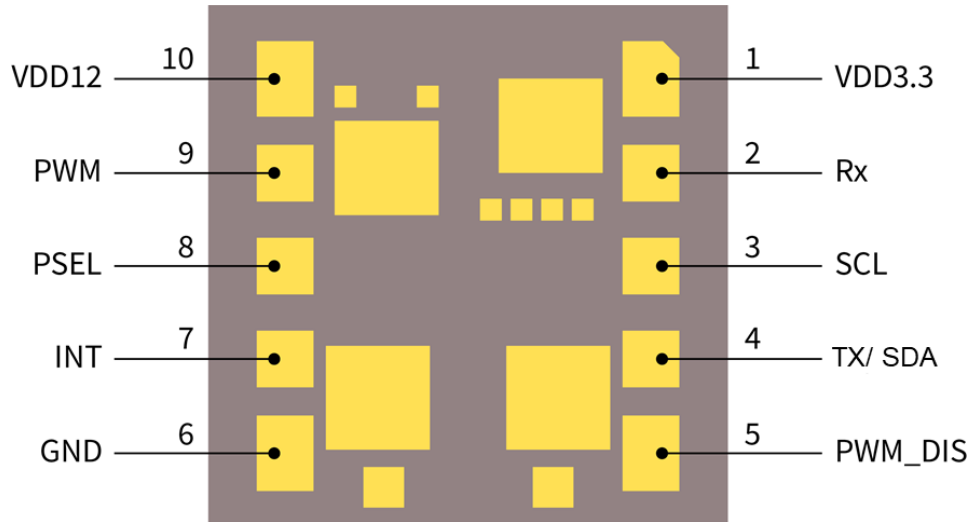

Figure 2 Pin-out diagram (Bottom view)

Table 1

PIN	Symbol	Type	Description
1	VDD3.3	Power supply (3.3V)	3.3V digital power supply
2	Rx	Input/ Output	UART receiver pin (3.3V domain)
3	SCL	Input/ Output	I2C clock pin (3.3V domain)
4	TX/ SDA	Output	UART transmitter pin (3.3V domain) / I2C data pin (3.3V domain)
5	PWM_DIS	Input	PWM disable input pin (3.3V domain)
6	GND	Ground	Ground
7	INT	Output	Interrupt output pin (3.3V domain)
8	PSEL	Input	Communication interface select input pin (3.3V domain)
9	PWM	Output	PWM output pin (3.3V domain)
10	VDD12	Power supply (12V)	12V power supply for the IR emitter

3 The typical sensor response to the CO₂ concentration change

Measurement condition: VDD12 = 12V, VDD3.3=3.3V, T_{amb} = 25°C, P = 1013 hPa and rH = 50%

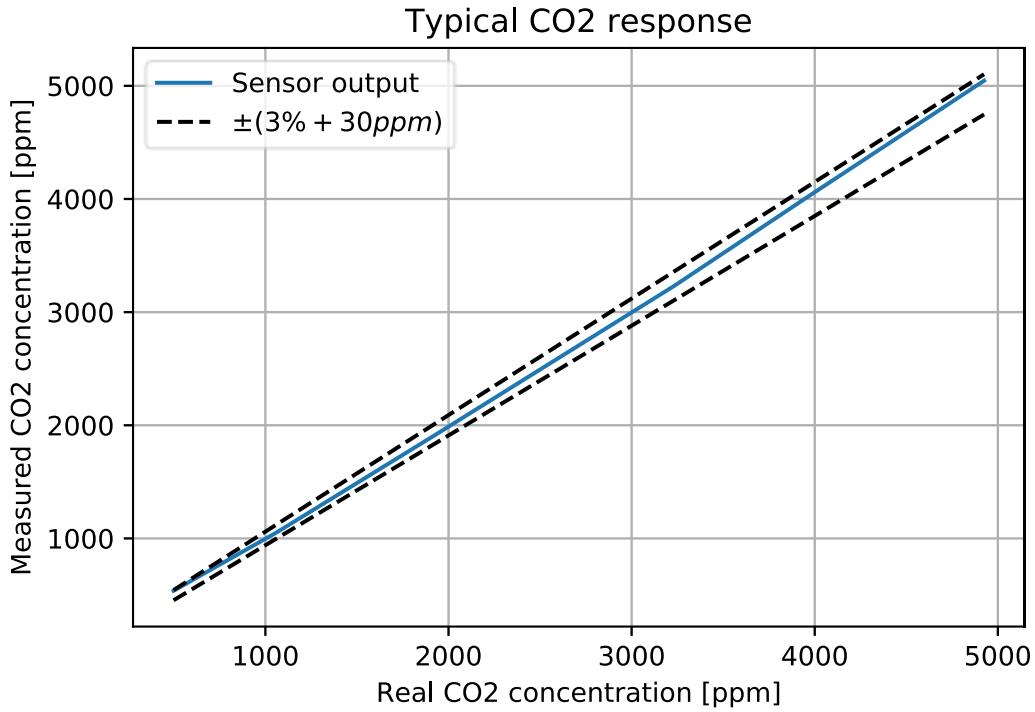

Figure 3 The typical sensor response to the CO₂ concentration change.

4 Characteristics and parameters

4.1 Specification

4.1.1 Operating range

The following operating conditions must not be exceeded to ensure proper operation of the sensor. All parameters specified in the following sections refer to these operating conditions unless otherwise specified.

Table 2 Operating range

Parameter	Symbol	Values			Unit	Note or Test Condition
		Min.	Typ.	Max.		
CO2 measurement range	C _{CO2}	0		10000	ppm	Functional measurement range
Ambient temperature	T _{amb}	0	25	50	°C	
Relative humidity	rH	0	50	85	%	Non-condensing
Pressure	p	750	1013	1150	hPa	
Supply voltage	VDD3.3	3	3.3	3.6	V	
	VDD12	10.8	12	13.2	V	
Lifetime	T _{life}		10		Year	At 1 meas/ min sampling rate

4.1.2 Timing characteristics

Table 3 Timing characteristics

Parameter	Symbol	Values			Unit	Note or Test Condition
		Min.	Typ.	Max.		
Sampling time	T _{sampling}	5		4095	s	
Time to sensor ready	T _{sensor_rdy}			1	s	
Time to early notification	T _{early_noti}		2		s	The only application for the continuous mode of operation
I2C Clock frequency	f _{I2C}		100		kHz	
			400			
PWM frequency	f _{pwm}		80		Hz	
UART baud rate	f _{baud}		9.6		kbps	

Typical measurement timing sequence for I2C and UART is presented in figure 4.

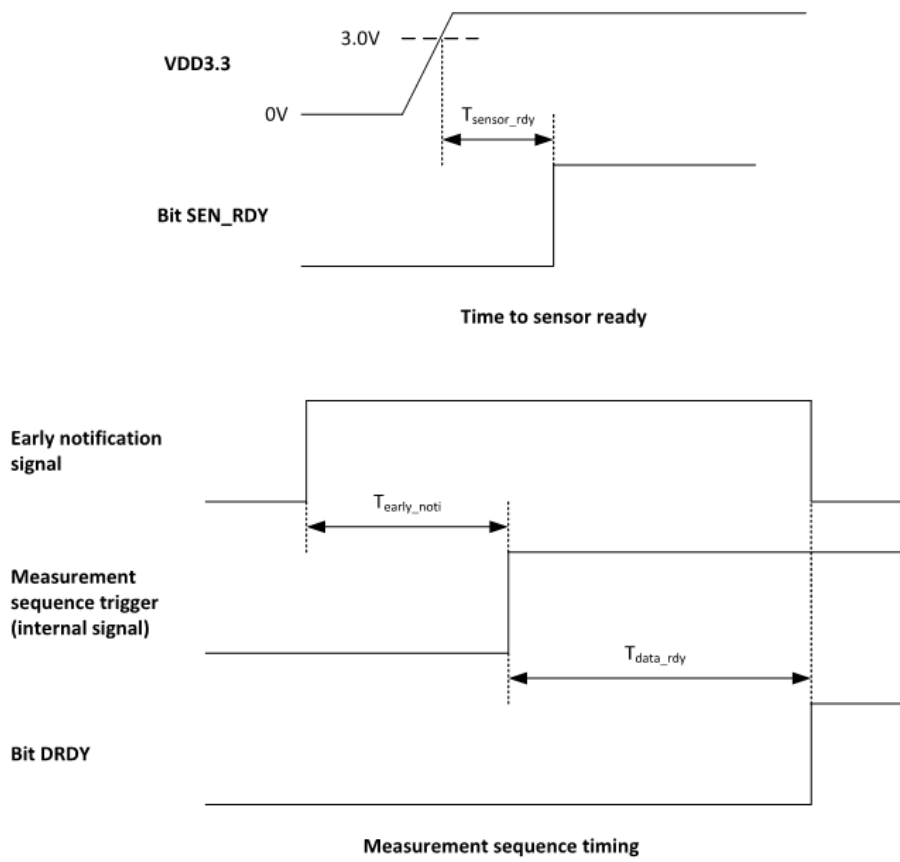

Figure 4 Measurement timing sequence

4.1.3 Absolute maximum ratings

Maximum ratings are absolute ratings. Exceeding any one of these values may cause irreversible damage to the sensor. Verified by design characterization, not tested during production.

Attention: Stresses above the values listed as "Absolute Maximum Ratings" may cause permanent damage to the devices. Exposure to absolute maximum rating conditions for extended periods may affect device reliability.

Table 4 Absolute Maximum Ratings

Parameter	Symbol	Values			Unit	Note or Test Condition
		Min.	Typ.	Max.		
MSL Level	MSL		6			6 hours of moisture soak time
Maximum ambient temperature	T _{amb_max}			TBD	°C	External temperature of the module
12V Supply voltage	V _{VDD12}	9.6		14.4	V	
3.3V Supply voltage	V _{VDD3.3}	3.0		3.6	V	
Storage temperature	T _s	-30		85	°C	
ESD Human Body Model	V _{ESD_HBM}	-2		2	kV	HBM (JS001)
ESD Charge Discharge Model	V _{ESD_CDM}			750	V	CDM (JS002)

4.1.4 The current rating and power consumption

The current rating refers to 1 measurement/ 60 seconds as a typical sampling frequency.

All parameters specified in table 5 refer to the following operating conditions unless otherwise specified: VDD3.3 = 3.3V, VDD12 = 12V, T_{amb} = 25°C, % rH = 50 %, p = 1013 hPa.

Table 5 Current rating

Parameter	Symbol	Pin	Values			Unit	Note or Test Condition
			Min.	Typ.	Max.		
Peak current ¹⁾	I _{peak 12}	VDD12		130	150	mA	
Peak current ¹⁾	I _{peak 3.3}	VDD3.3		10		mA	
Average current ¹⁾	I _{avg 12}	VDD12		0.8		mA	
Average current ¹⁾	I _{avg 3.3}	VDD3.3		6.1		mA	
Average power ¹⁾	P _{avg}			30		mW	

Note: 1) Not subject to production test. This parameter is verified by design/ characterization.

Power consumption can be optimized further which has been covered in a separate application note.

4.1.5 CO2 Transfer Function

All parameters specified in the following sections refer to the operating conditions unless otherwise specified:

VDD3.3 = 3.3V, VDD12 = 12V, T_{amb} = 25°C, % rH = 30 %, p = 1013 hPa.

Table 6 CO₂ Transfer Function

Parameter	Symbol	Values			Unit	Conditions
		Min.	Typ	Max.		
Accuracy	Acc	-30 ppm- 3% of reading		+30 ppm+3% of reading	ppm	C _{CO2} : 400 - 5000 ppm
Response time ¹⁾	T ₆₃		75		s	
Pressure stability ¹⁾	p _{error}		0.1		%/hPa	Without pressure input. The impact can be minimized with pressure input.
Drift ¹⁾	d _{error}			1	%/ year	At 1 measurement per minute with ABOC enabled
Acoustic stability ¹⁾	SPL _{error}	3	6	15	ppm	Up to 95 dB for Pink noise from 100 Hz to 10 kHz.

Note: 1) Not subject to production test. This parameter is verified by design/ characterization.

4.1.6 Peripheral timing

4.1.6.1 I2C Timing

Table 7 I2C Standard mode timing

Parameter	Symbol	Values			Unit	Note or Test Condition
		Min.	Typ.	Max.		
Fall time of both SDA and SCL	t_1			300	ns	
The rise time of both SDA and SCL	t_2			1000	ns	
Data hold time	t_3	0			μ s	
Data set-up time	t_4	250			ns	
LOW period of SCL clock	t_5	4.7			μ s	
HIGH period of SCL clock	t_6	4.0			μ s	
Hold time for a (repeated) START condition	t_7	4.0			μ s	
Set-up time for (repeated) START condition	t_8	4.7			μ s	
Set-up time for STOP condition	t_9	4.0			μ s	
Bus free time between a STOP and START condition	t_{10}	4.7			μ s	
Capacitive load for each bus line	C_b			400	pF	

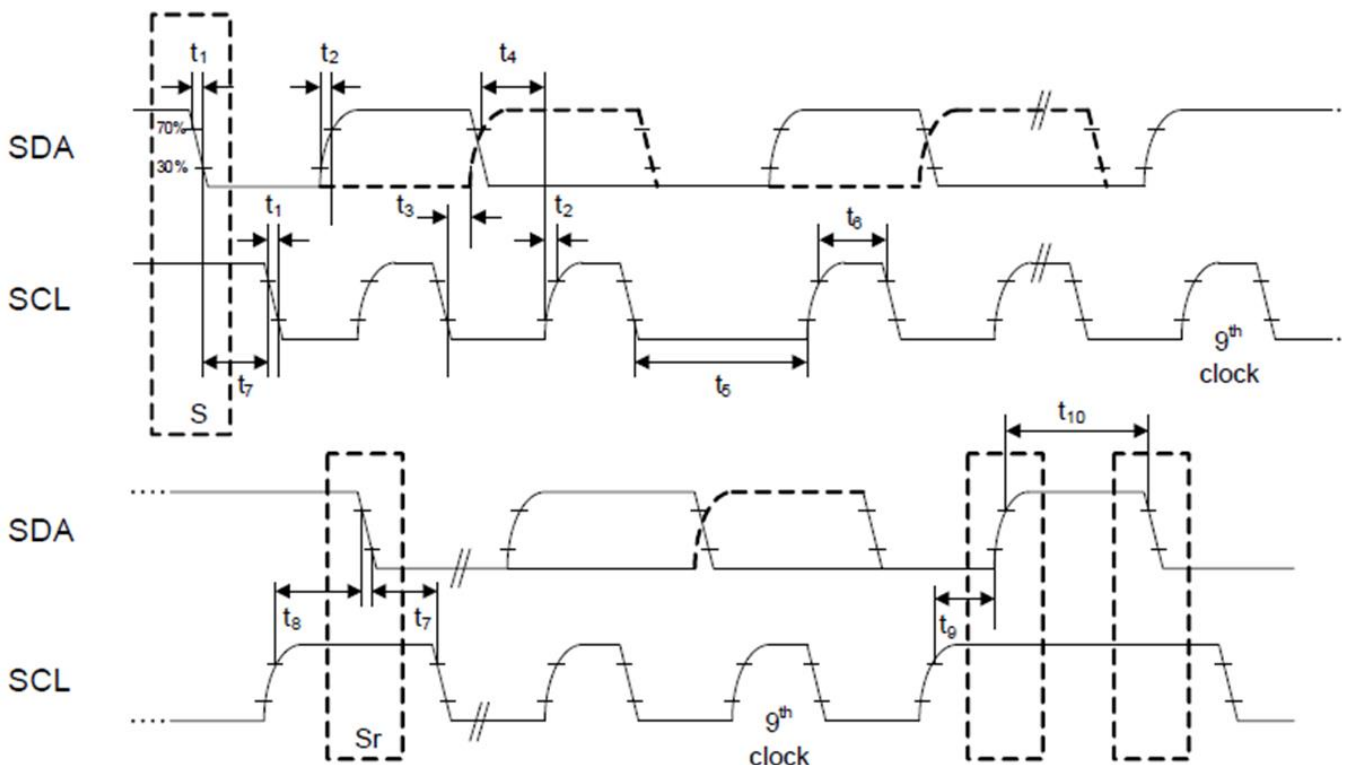

Figure 5 Standard I2C mode timing.

4.2 Application Circuit Example

Typical application circuit operating at I2C has been presented in the following figure:

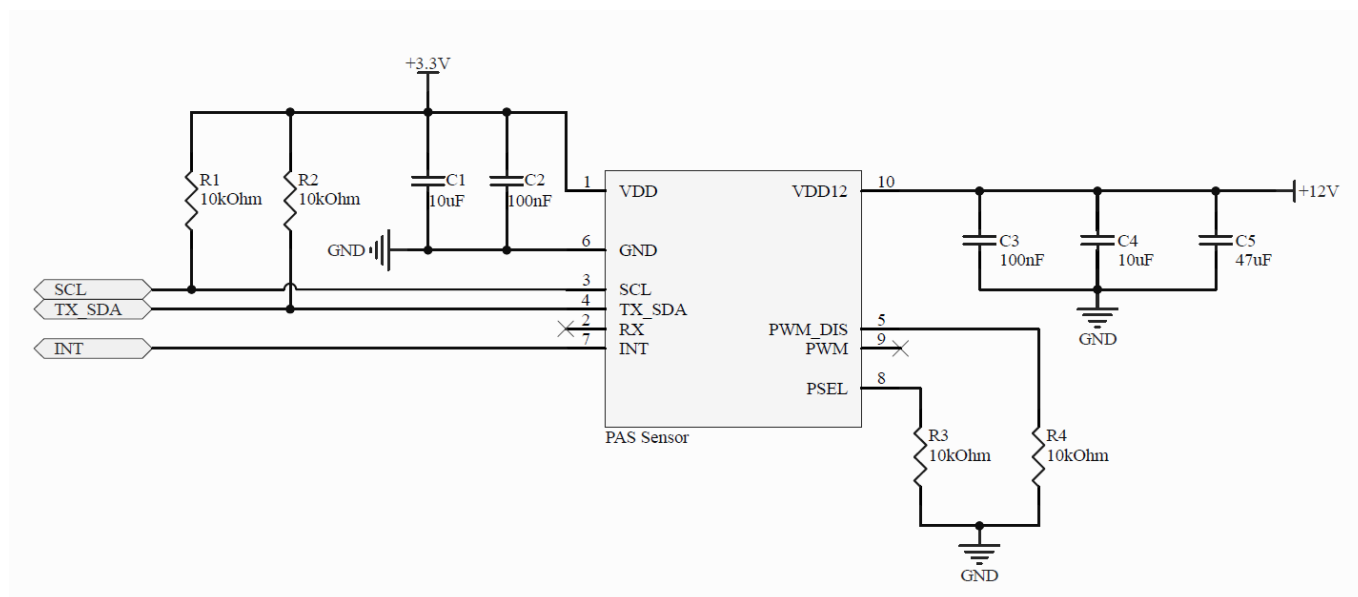

Figure 6 Application circuit example for I2C

4.3 Functional description

This section describes the operation of the sensor while measuring CO2 concentrations. At any moment the device can be in one out of two different states: active and inactive.

- Active state
- Inactive state

At active state, the CPU controlling the device is operating and can perform tasks such as: running a measurement sequence, serving an interrupt, etc. When the device has no specific task to perform, it goes to an inactive state. A transition from active to inactive state may occur at the end of a measurement sequence. In an inactive state, the CPU controlling the device is in sleep mode to optimize power consumption. Several events can wake up the device: the reception of a message on the serial communication interface, a falling edge on pin **PWM_DIS**, the internal generation of a measurement request in continuous measurement mode.

4.3.1 Operating Modes

The operating mode can be programmed via the serial communication interface by using the bit field **MEAS_CFG.OP_MODE**.

The sensor module supports three operating modes:

- **Idle mode:** The device does not perform any CO2 concentration measurement. The device remains inactive until it becomes active shortly to serve interrupts before going back to an inactive state.
- **Continuous mode:** In this mode, the device periodically triggers a CO2 concentration measurement sequence. Once a measurement sequence is completed, the device goes back to an inactive state and wakes up automatically for the next measurement sequence. The measurement period is programmable from 5 sec to 4095 sec.

- **Single-shot mode:** In this mode, the device triggers a single measurement sequence. At the end of the measurement sequence, the device goes back automatically to idle mode.

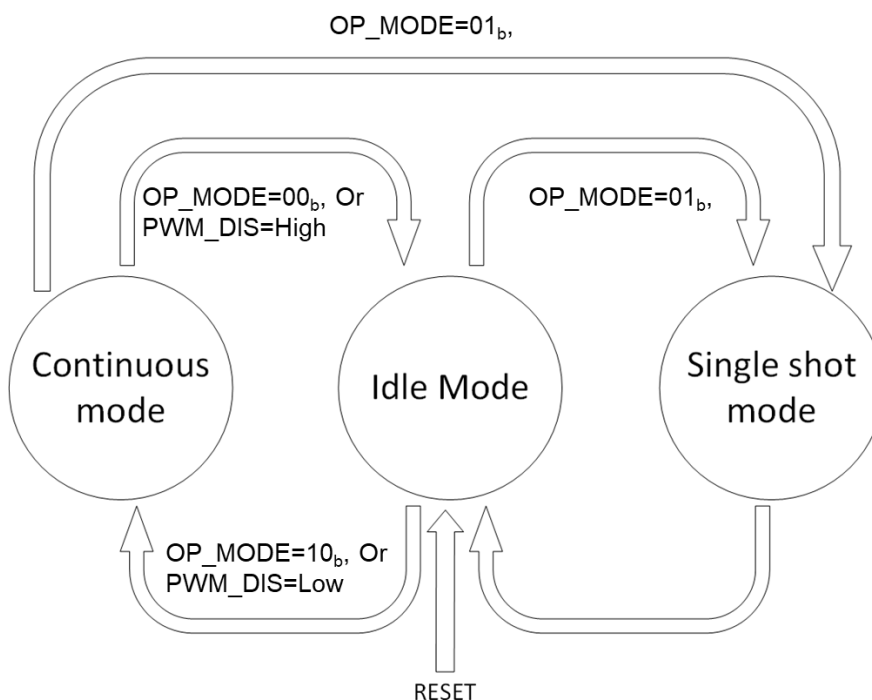

Figure 7 Operating mode transition

4.3.2 Data post-processing

Once the CO₂ concentration data has been acquired, several post-processing schemes can be applied to improve the sensor performance.

- **Pressure compensation**

The CO₂ concentration value acquired by the sensor is dependent on the external atmospheric pressure. To compensate for this effect, the application system can provide the value of the atmospheric pressure by writing into the specific registers, i.e. **PRESSREF_H** and **PRESSREF_L**. At the end of a measurement sequence, the device reads the pressure value and applies for compensation on the CO₂ concentration value before storing it into the result registers.

- **Automatic Baseline Offset Compensation**

To correct slow drifts caused by aging during operation, the device supports Automatic Baseline Offset Compensation. Every week of operation, the device computes an offset to correct the baseline of the device. The device must be in contact with the reference concentration (e.g. fresh air at 400 ppm of CO₂ concentration) at least 3 hours per operating week to make sure proper baseline compensation. The device supports different configurations for compensation. **The ABOC setpoint may only be set between 350 and 900 ppm.**

- **Forced compensation**

Forced compensation provides a means to speed up the offset compensation process. Before forced compensation is enabled, the device shall be physically exposed to the reference CO₂ concentration. The device will use the 10 next measurements to calculate the compensation offset. The user shall ensure constant exposure to the reference CO₂ concentration during that time. It is recommended to operate at 1 measurement per 10 seconds while implementing the forced compensation scheme. When the 10 measurement sequences are

completed, the device automatically reconfigures itself with the newly computed offset applied to the subsequent CO2 concentration measurement results.

4.3.3 Alarm Threshold

The device can be configured to perform an alarm threshold check each time a new CO2 concentration data is acquired. At the end of each measurement sequence, the computed CO2 value (after all applicable offset compensations) is compared to the concatenated value in **ALARM_TH_H** and **ALARM_TH_L**. In case of a threshold violation, the sticky bit **MEAS_STS.ALARM** is set. This also sets pin **INT** to active level if configured as Alarm. Bit **MEAS_STS.ALARM** is cleared by reading register **MEAS_STS.ALARM_CLR**.

4.4 Advanced functionality

Monitoring mechanism

The device supports several mechanisms to monitor the correct operation of the sensor.

Table 4

Mechanism	Description
Sensor Ready status	After each power-on reset, bit SENS_STS.SEN_RDY is set to confirm that the sensor has initialized correctly.
Scratchpad register	To check the integrity of the communication layer of the serial communication interface, register SCRATCH_PAD can be used. This register can use this memory field to write any value and verify that the data received by the device is correct. It can also be used to verify that a soft reset has been executed, using the following sequence: <ol style="list-style-type: none"> 1. The user writes a non-default value to register SCRATCH_PAD. 2. The user reads back register SCRATCH_PAD to verify the writ commend has been correctly executed. 3. The user writes register SENS_RST to trigger a soft reset. 4. The user reads register SCRATCH_PAD to verify that it has been reset to its default value.
VDD12V verification	At power-up and the beginning of each measurement sequence, the device measures automatically the voltage at VDD12 . If the measured voltage exceeds the specified operating range of the device, bit SENS_STS.ORVS is set. The measurement sequence is however completed normally. Bit SENS_STS.ORVS can be cleared by setting bit SENS_STS.ORVS_CLR
Internal temperature verification	At the beginning of each measurement sequence, the device measures automatically its internal temperature. If the measured temperature exceeds the specified operating ranged of the device, sticky bit SENS_STS.ORTMP is set. The measurement sequence is however completed normally. Bit SENS_STS.ORTMP can be cleared by setting bit SENS_STS.ORTMP_CLR .

4.5 Digital interface

The XENSIV™ PAS CO2 supports I2C, UART, and PWM. The communication protocols have been covered in separate application notes.

4.5.1 I2C interface

The device complies with the I2C protocol. When I2C is selected as a serial communication interface, the device acts as an I2C slave. The main characteristics of the interface are described below:

- Slave mode only.
- I2C Clock frequency: 100 kHz and 400 kHz
- 7-bit slave address: 0x28
- No CRC.
- The device supports clock stretching.
- 8bit addressing mode supported (7bit address + RW)
- Bulk read and write supported (device auto-increments automatically the address).
- Address 0x00 not supported.

Further details of the protocol are covered in the separate application note.

4.5.2 I2C transaction format

The I2C transaction has the following structure: a start condition followed by four bytes followed a stop condition.

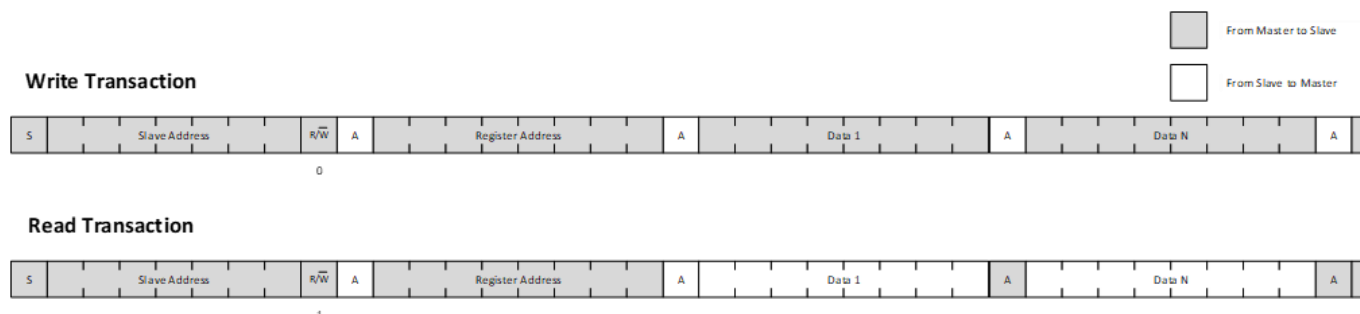

Figure 8 I2C write and read transaction

Table 5

Byte	Description	Value	Comments
	Start condition		
1	Header	(Slave Address << 1) R/W	
2	First data-byte	As per user request/register value	Read: data provided by the slave Write: data provided by the user
N+2	Data byte N	As per user request/register value	Read: data provided by the slave Write: data provided by the user
	End condition		

4.5.3 UART Interface

When UART is selected as a serial communication interface, the device acts as a UART slave. The device operates via UART for point-to-point communication. Bus operation is not supported. As a result, it is recommended that the master uses a time-out mechanism. The basic format of a valid UART frame is 1 start bit, 8 data bits, no parity bit, and 1 stop bit. The master combines several UART frames into a message (read or write). The combination of master request and slave answer defines a transaction. The main characteristics of the interface are described below:

- Point to point operation – no bus support.
- Slave operation only.
- UART clock frequency = 9.6 kHz
- Format: 1 start bit, 8 Data bits, no parity bit, 1 stop bit. Supports direct connection with a terminal program.

For further details on UART communication, please have a look at the application note titled ‘Register map description of XENSIV™ PAS CO2’ and ‘Programming guide for XENSIV™ PAS CO2’ on the product website ‘www.infineon.com/CO2’.

4.6 Register map

Name	Address	Bit 7	Bit 6	Bit 5	Bit 4	Bit 3	Bit 2	Bit 1	Bit 0	Reset	
PROD_ID	0x00	PROD r			REV r						0x4A
SENS_STS	0x01	SEN_RDY rh	PWM_DIS_ST rh	ORTMP rhs	ORVS rhs	ICCER rhs	ORTMP_CLR w	ORVS_CLR w	ICCER_CLR w	0xC0	
MEAS_RATE_H	0x02	VAL rwh									0x00
MEAS_RATE_L	0x03	VAL rwh									0x3C
MEAS_CFG	0x04	0 rw	PWM_OUTEN rw	PWM_MODE rw	BOC_CFG rwh			OP_MODE rwh		0x24	
CO2PPM_H	0x05	VAL r									0x00
CO2PPM_L	0x06	VAL r									0x00
MEAS_STS	0x07	0 rw	Res rh	DRDY rhs	INT_STS rhs	ALARM rhs	INT_STS_CLR w	ALARM_CLR w		0x00	
INT_CFG	0x08	0 rw			INT_TYP rw	INT_FUNC rw			ALARM_TYP rw	0x11	
ALARM_TH_H	0x09	VAL rw									0x00
ALARM_TH_L	0x0A	VAL rw									0x00
PRESS_REF_H	0x0B	VAL rwh									0x03
PRESS_REF_L	0x0C	VAL rwh									0xF7
CALIB_REF_H	0x0D	VAL rwh									0x01
CALIB_REF_L	0x0E	VAL rwh									0x90
SCRATCH_PAD	0x0F	VAL rw									0x00
SENS_RST	0x10	SRTRG w									0x00
Reserved	0x11 ... 0x14	Reserved registers Read & Write access to those registers generate a communication error									
Reserved	0x15 ... 0xFF	Reserved registers Read & Write access to those registers generate a non-acknowledge condition.									

Complete 'Register description' has been covered in a separate application note.

5 Package information

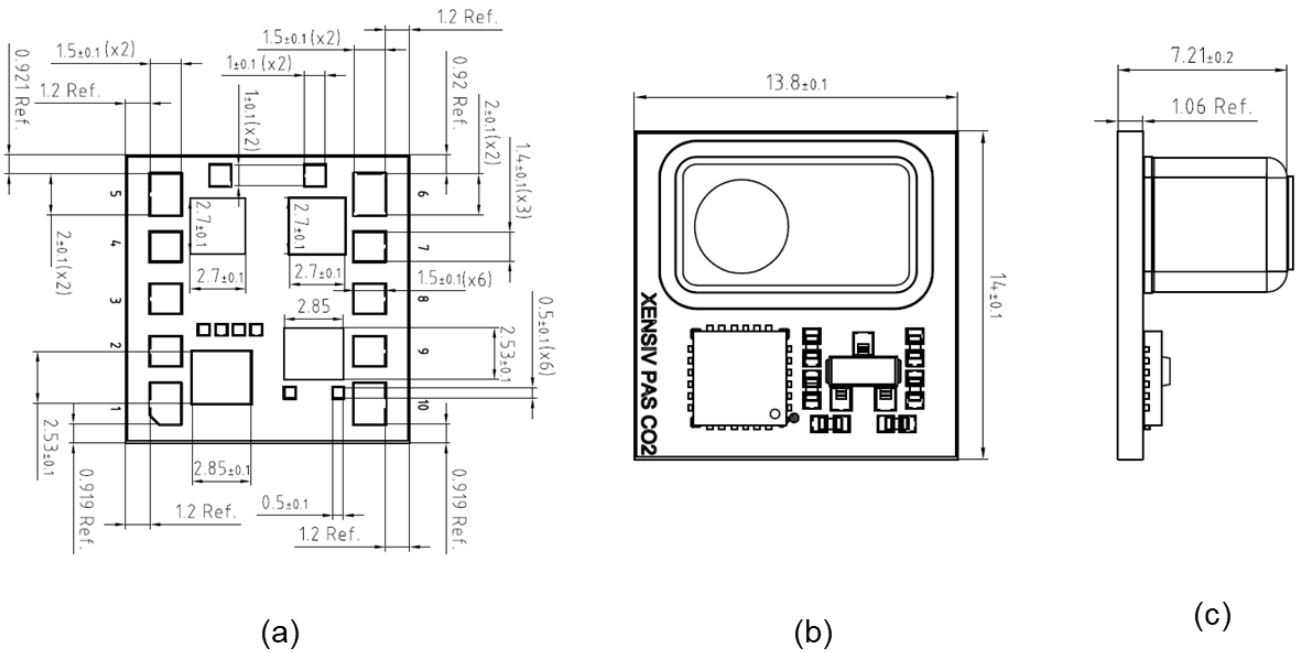
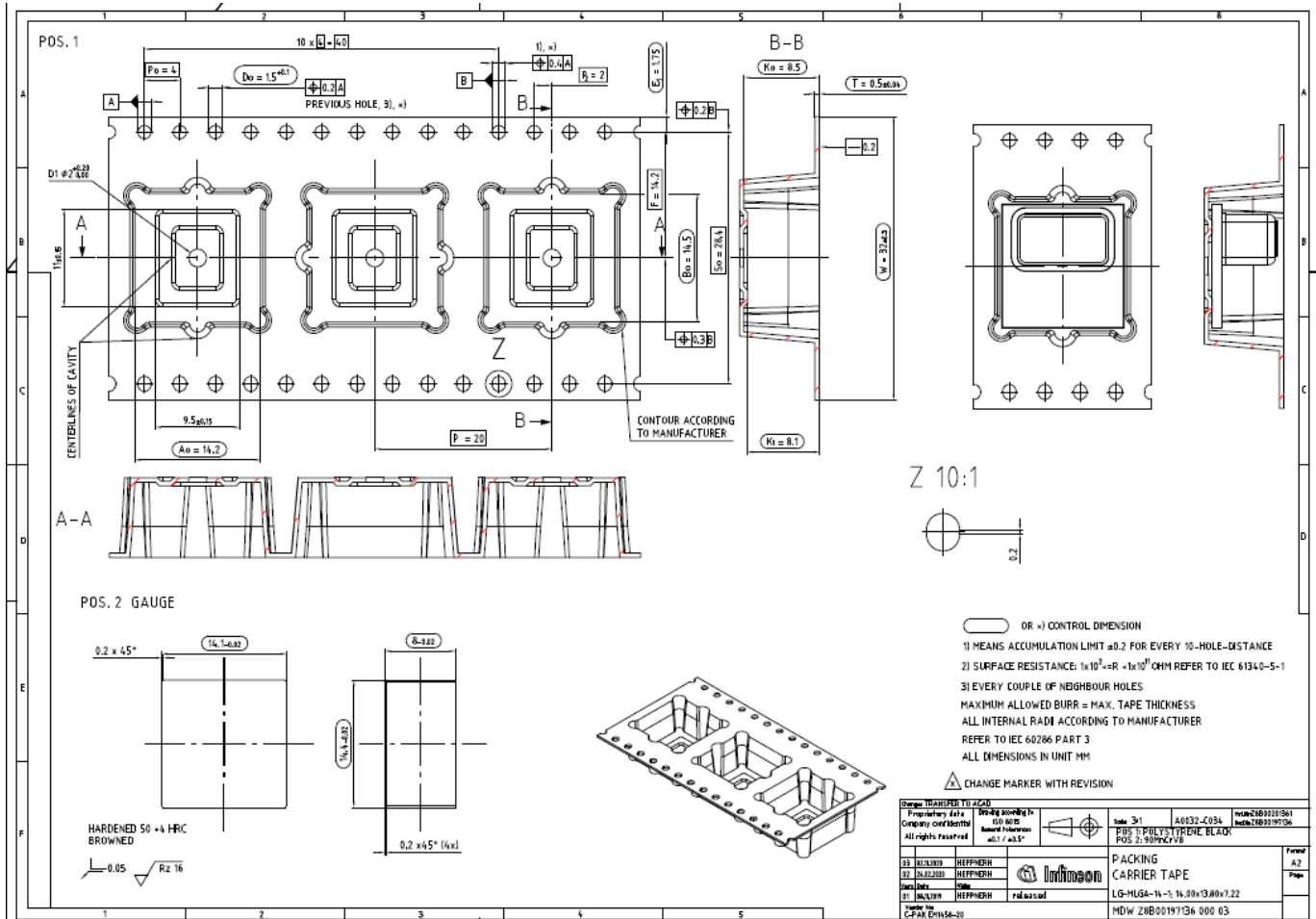

Figure 9 (a) Bottom view (b) Top view and (c) Side view. All dimensions are in mm.

6 Packing for shipment

The device will be shipped in tape and reel. Each tape and reel consist of 350 parts. The assembly instruction has been covered in a separate application note.



7 Revision history

Table 6

Reference	Description	Date
0.1	First copy	13.10.2020
0.2	Second copy	25.06.2021

Trademarks

All referenced product or service names and trademarks are the property of their respective owners.

Edition 2021-06-25

Published by

Infineon Technologies AG

81726 München, Germany

© 2021 Infineon Technologies AG.

All Rights Reserved.

Do you have a question about this document?

Email: erratum@infineon.com

Document reference

ifx1

IMPORTANT NOTICE

The information given in this document shall in no event be regarded as a guarantee of conditions or characteristics ("Beschaffheitsgarantie").

With respect to any examples, hints or any typical values stated herein and/or any information regarding the application of the product, Infineon Technologies hereby disclaims any and all warranties and liabilities of any kind, including without limitation warranties of non-infringement of intellectual property rights of any third party.

In addition, any information given in this document is subject to customer's compliance with its obligations stated in this document and any applicable legal requirements, norms and standards concerning customer's products and any use of the product of Infineon Technologies in customer's applications.

The data contained in this document is exclusively intended for technically trained staff. It is the responsibility of customer's technical departments to evaluate the suitability of the product for the intended application and the completeness of the product information given in this document with respect to such application.

For further information on the product, technology delivery terms and conditions and prices please contact your nearest Infineon Technologies office (www.infineon.com).

WARNINGS

Due to technical requirements products may contain dangerous substances. For information on the types in question please contact your nearest Infineon Technologies office.

Except as otherwise explicitly approved by Infineon Technologies in a written document signed by authorized representatives of Infineon Technologies, Infineon Technologies' products may not be used in any applications where a failure of the product or any consequences of the use thereof reasonably be expected to result in personal injury.