

2213362-4 ✓ ACTIVE

LUMAWISE | LUMAWISE Dimming Receptacle

TE Internal #: 2213362-4

ANSI Street Lighting Receptacles, Connector, Not Rotatable, Wire-to-Component, 7 Position, Sealable, Wire & Cable, LUMAWISE Dimming Receptacle

[View on TE.com >](#)



Connectors > Lighting Connectors > Street Lighting Controls > ANSI Street Lighting Receptacles > Dimming Receptacle

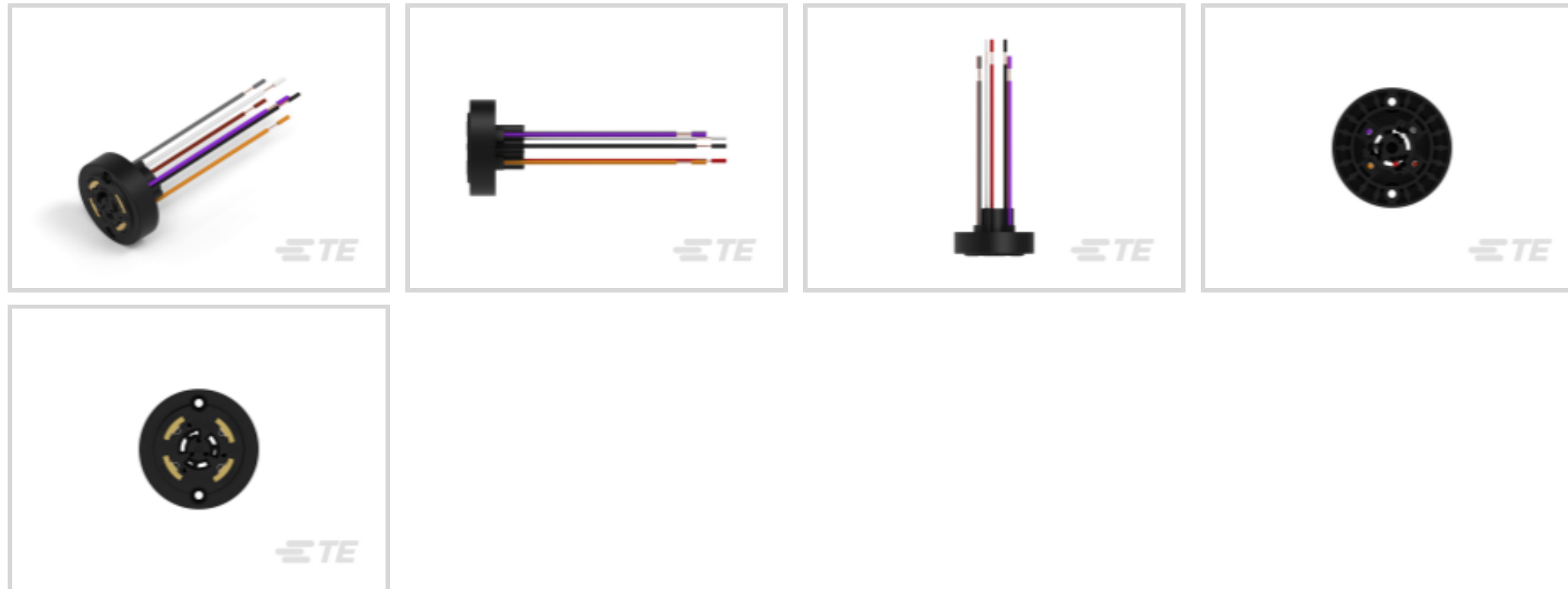

Lighting Product Type: **Connector**

Lighting Connector Features Included: **Not Rotatable**

Connector System: **Wire-to-Component**

Number of Positions: 7

Sealable: **Yes**

[All Dimming Receptacle \(5\)](#)

## Features

### Product Type Features

Lighting Product Type	Connector
Connector System	Wire-to-Component
Sealable	Yes
Connector & Contact Terminates To	Wire & Cable

### Configuration Features

Lighting Connector Features Included	Not Rotatable
Number of Positions	7

### Electrical Characteristics

Operating Voltage	600 VAC
-------------------	---------

### Contact Features

Contact Mating Area Plating Material	Gold
Contact Current Rating (Max)	15 A



### Housing Features

Housing Color	Black
---------------	-------

### Dimensions

Wire Size	18 – 14 AWG
-----------	-------------

### Usage Conditions

Operating Temperature Range	-40 – 85 °C[-40 – 185 °F]
-----------------------------	---------------------------

### Operation/Application

Circuit Application	Power & Signal
---------------------	----------------

### Industry Standards

Agency/Standard	ANSI
-----------------	------

## Product Compliance

[For compliance documentation, visit the product page on TE.com>](#)













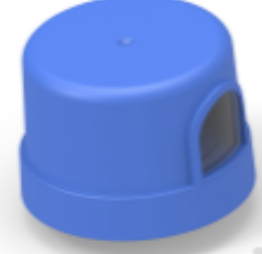



EU RoHS Directive 2011/65/EU	Compliant
EU ELV Directive 2000/53/EC	Compliant
China RoHS 2 Directive MIIT Order No 32, 2016	No Restricted Materials Above Threshold
EU REACH Regulation (EC) No. 1907/2006	Current ECHA Candidate List: JUNE 2022 (224) Candidate List Declared Against: JUNE 2022 (224) Does not contain REACH SVHC
Halogen Content	Not Low Halogen - contains Br or Cl > 900 ppm.
Solder Process Capability	Not applicable for solder process capability

#### Product Compliance Disclaimer

This information is provided based on reasonable inquiry of our suppliers and represents our current actual knowledge based on the information they provided. This information is subject to change. The part numbers that TE has identified as EU RoHS compliant have a maximum concentration of 0.1% by weight in homogenous materials for lead, hexavalent chromium, mercury, PBB, PBDE, DBP, BBP, DEHP, DIBP, and 0.01% for cadmium, or qualify for an exemption to these limits as defined in the Annexes of Directive 2011/65/EU (RoHS2). Finished electrical and electronic equipment products will be CE marked as required by Directive 2011/65/EU. Components may not be CE marked. Additionally, the part numbers that TE has identified as EU ELV compliant have a maximum concentration of 0.1% by weight in homogenous materials for lead, hexavalent chromium, and mercury, and 0.01% for cadmium, or qualify for an exemption to these limits as defined in the Annexes of Directive 2000/53/EC (ELV). Regarding the REACH Regulation, the information TE provides on SVHC in articles for this part number is based on the latest European Chemicals Agency (ECHA) 'Guidance on requirements for substances in articles' posted at this URL: <https://echa.europa.eu/guidance-documents/guidance-on-reach>

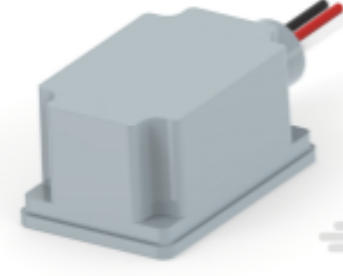
## Compatible Parts

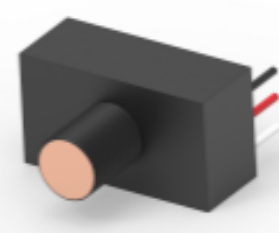

 <p>TE Part # CAT-ST833-P5663A Photo Control Base</p>	 <p>TE Part # J2745D-000 ALR-NS-10ANSI</p>	 <p>TE Part # 812812-000 ALR-BF-PV</p>	 <p>TE Part # BB3399-000 ALR-8090-VFS</p>
 <p>TE Part # D02595-000 ALR-SC-10A-(B-125)</p>	 <p>TE Part # 2213469-1 GASKET, PHOTOCCELL RECEPTACLE</p>	 <p>TE Part # 022528-000 ALR-BF-208-277</p>	 <p>TE Part # 131520-000 ALR-AA-1068</p>
 <p>TE Part # 1-2325661-1 LUMAWISE ENDURANCE N SHRTG CAP BASE VENT</p>	 <p>TE Part # 2314786-2 LUMAWISE N ENHANCED BASE, FM OFF, ZC YES</p>	 <p>TE Part # 2325661-1 LUMAWISE ENDURANCE N SHRTNG CAP BASE ASM</p>	 <p>TE Part # 2336396-2 ASSEMBLY, LIGHT CONTROLLER BASE, W/VENT</p>
 <p>TE Part # 301910-000 ALR-AT-168</p>	 <p>TE Part # 635008-000 ALR-AT-20</p>	 <p>TE Part # 395430-000 ALR-PT-168</p>	 <p>TE Part # 698376-000 ALR-BF-120</p>
 <p>TE Part # 908604-000 ALR-TL-115</p>	 <p>TE Part # 499268-000 ALR-AA-105</p>	 <p>TE Part # 636452-000 ALR-M-480</p>	 <p>TE Part # 797970-000 ALR-SPT-15</p>

Also in the Series | **LUMAWISE Dimming Receptacle**

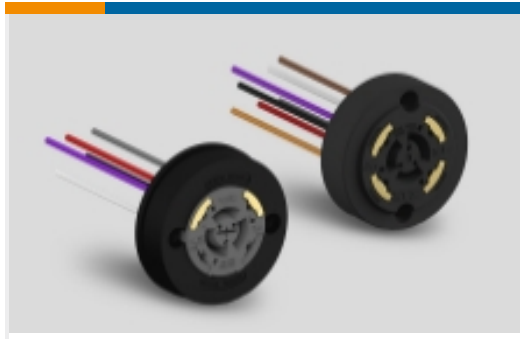

ANSI Street Lighting Receptacles(24)

## Customers Also Bought



TE Part #2834048-1  
PLUG, 2P LATCHED POKE-IN WTW  
CONN.NL



TE Part #2213626-1  
GASKET, SEALING ROT DIM RECEPT

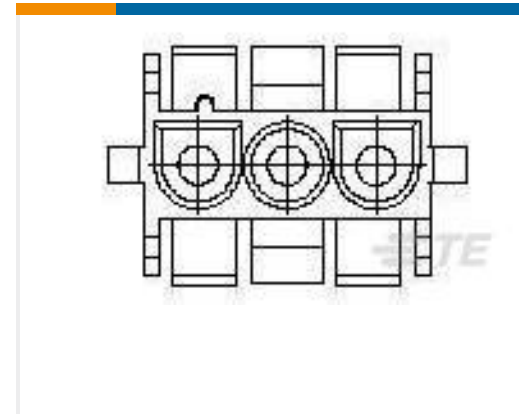

TE Part #794900-1  
03P UMNL HI TEMP CAP HSG



TE Part #1-2213362-4  
RCPT ASSY,DIMMABLE  
PHOTOCONTROL,105C,3/4

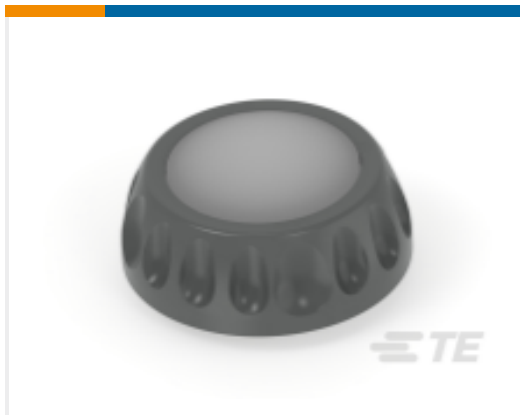

TE Part #2388426-1  
ASSEMBLY, SENSOR LUMAWISE  
MOTION

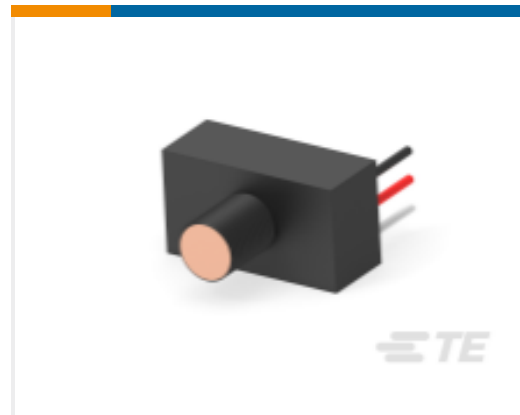

TE Part #150452-000  
ALR-AA-105-9IN



TE Part #1-2376865-0  
Rcpt Assy, w/ intg gasket; PC; dimm 3  
/2



TE Part #1-2376865-1  
RCPT ASSY, W/ INTG GASKET; PC;  
DIMM 3/4



TE Part #2376865-9  
Rcpt Assy, w/ intg gasket; PC; 3P

## Documents

### Product Drawings

[RCPT ASSY,DIMMABLE PHOTOCONTROL,105C,3/4](#)

English

### CAD Files

[Customer View Model](#)

[ENG\\_CVM\\_CVM\\_2213362-4\\_B.3d\\_igs.zip](#)

English

[Customer View Model](#)



[ENG\\_CVM\\_CVM\\_2213362-4\\_B.3d\\_stp.zip](#)

English

**Customer View Model**

[ENG\\_CVM\\_CVM\\_2213362-4\\_B.2d\\_dxf.zip](#)

English

**3D PDF**

3D

By downloading the CAD file I accept and agree to the [Terms and Conditions](#) of use.

---

### Datasheets & Catalog Pages

[LUMAWISE STREET LIGHT DIMMING AND CONTROL QUICK REFERENCE GUIDE](#)

English

[LUMAWISE Endurance N ANSI C136.41 Standard Dimming Receptacle Assembly](#)

English

---

### Product Specifications

[Application Specification](#)

English

[Application Specification](#)

English

---

### Product Environmental Compliance

[MD\\_2213362-4\\_02082016735\\_dmtec](#)

English

[MD\\_2213362-4\\_02082016735\\_dmtec](#)

English

---

### Agency Approvals

[UL\\_CERT\\_CB\\_4789600659\\_TR\\_C1](#)

English

[UL\\_CERT\\_CB\\_US\\_37285\\_C1](#)

English