

206708-1 ✓ ACTIVE

AMP | AMP CPC

TE Internal #: 206708-1

Circular Power Connectors, Housing, 600 VDC, Wire-to-Wire, 9 Position, Wire & Cable, Plug, Socket, Power & Signal, Black, All Plastic, AMP CPC

[View on TE.com >](#)



Connectors > Power Connectors > Circular Power > Circular Power Connectors > Circular Connector, Environmentally Sealed, CPC Series 6



Connector Product Type: **Housing**

Operating Voltage: **600 VDC**

Connector System: **Wire-to-Wire**

Number of Positions: **9**

Sealable: **No**

[All Circular Connector, Environmentally Sealed, CPC Series 6 \(19\)](#)

## Features

### Product Type Features

Connector Product Type	Housing
Connector System	Wire-to-Wire
Sealable	No
Connector & Contact Terminates To	Wire & Cable
Connector & Housing Type	Plug
Circular Connector Shell Type	All Plastic

### Configuration Features

Reverse Numbering	Without
Number of Positions	9
Number of Power Positions	0
Number of Signal Positions	9

### Electrical Characteristics



Operating Voltage	600 VAC
-------------------	---------

### Contact Features

Reverse Gender	No
----------------	----

Contact Type	Socket
--------------	--------

Contact Protection	With
--------------------	------

### Mechanical Attachment

Mating Alignment Type	Keyed
-----------------------	-------

Mating Alignment	With
------------------	------

Mating Retention Type	Threaded Coupling
-----------------------	-------------------

Screw & Hole Thread Size	3/4 - 20 UNEF-2A
--------------------------	------------------

Polarization Code	A
-------------------	---

Connector Mounting Type	Cable Mount (Free-Hanging)
-------------------------	----------------------------

Mating Retention	With
------------------	------

Panel Mount Feature	Without
---------------------	---------

### Housing Features

Body Orientation	Straight
------------------	----------

Housing Color	Black
---------------	-------

Housing Material	Thermoplastic
------------------	---------------

Circular Connector Shell Size	13
-------------------------------	----

### Usage Conditions

Operating Temperature Range	-55 – 105 °C[-67 – 221 °F]
-----------------------------	----------------------------

Fluid Resistance	None
------------------	------

### Operation/Application

Circuit Application	Power & Signal
---------------------	----------------

Shielded	No
----------	----

### Industry Standards

UL Flammability Rating	UL 94V-0
------------------------	----------

### Packaging Features

Packaging Quantity	100
--------------------	-----

Packaging Method	Standard
------------------	----------

### Product Compliance









[For compliance documentation, visit the product page on TE.com>](#)

EU RoHS Directive 2011/65/EU	Compliant
EU ELV Directive 2000/53/EC	Compliant
China RoHS 2 Directive MIIT Order No 32, 2016	No Restricted Materials Above Threshold
EU REACH Regulation (EC) No. 1907/2006	Current ECHA Candidate List: JUNE 2022 (224) Candidate List Declared Against: JUNE 2022 (224) Does not contain REACH SVHC
Halogen Content	BFR/CFR/PVC Free, but Br/Cl >900 ppm in other sources.
Solder Process Capability	Not applicable for solder process capability

#### Product Compliance Disclaimer

This information is provided based on reasonable inquiry of our suppliers and represents our current actual knowledge based on the information they provided. This information is subject to change. The part numbers that TE has identified as EU RoHS compliant have a maximum concentration of 0.1% by weight in homogenous materials for lead, hexavalent chromium, mercury, PBB, PBDE, DBP, BBP, DEHP, DIBP, and 0.01% for cadmium, or qualify for an exemption to these limits as defined in the Annexes of Directive 2011/65/EU (RoHS2). Finished electrical and electronic equipment products will be CE marked as required by Directive 2011/65/EU. Components may not be CE marked. Additionally, the part numbers that TE has identified as EU ELV compliant have a maximum concentration of 0.1% by weight in homogenous materials for lead, hexavalent chromium, and mercury, and 0.01% for cadmium, or qualify for an exemption to these limits as defined in the Annexes of Directive 2000/53/EC (ELV). Regarding the REACH Regulation, the information TE provides on SVHC in articles for this part number is based on the latest European Chemicals Agency (ECHA) 'Guidance on requirements for substances in articles' posted at this URL: <https://echa.europa.eu/guidance-documents/guidance-on-reach>

## Compatible Parts

 <p>TE Part # CAT-AM71-A17 POWERBAND Contacts</p>	 <p>TE Part # 54123-1 CPC,13 LONG TUBE</p>	 <p>TE Part # CAT-AM71-C83998AA Two-Piece Receptacle, CPC Series 6</p>	 <p>TE Part # 81665-4 ECONOSEAL, FLANGE GASKET</p>
 <p>TE Part # 211399-1 CPC PLUG ASSEMBLY SIZE 13-7</p>	 <p>TE Part # CAT-AM71-C83998J Cable/Panel Mount Connector, CPC Series 1</p>	 <p>TE Part # CAT-AM71-T98 Pin and Socket Contacts, Type II</p>	 <p>TE Part # CAT-AM71-T98E Pin and Socket Contacts, Type III, LP</p>

TE Part # CAT-AM71-T98D  
Pin and Socket Contacts, Type III, LP  
EMEA



TE Part # CAT-AM71-T98A  
Strip Pin and Socket Contacts, Type III,  
LP



TE Part # CAT-AM71-T98G  
Pin and Socket Contacts, Type III, LP,  
High Current



TE Part # CAT-AM71-T98B  
Strip Pin and Socket Contacts, Type III



TE Part # CAT-AM71-T98F  
Strip Pin and Socket Contacts, Type III,  
High Current



TE Part # CAT-AM71-C83998F  
Connectors with Posted Pin Contacts,  
CPC Series 1



TE Part # CAT-AM71-C83998B  
CPC Cable Clamps



TE Part # 211870-2  
SEALING CAP ASSY, SZ 13, CPC



TE Part # 91542-1  
CCII TYPE III+ PIN SKT 24-22 ASSY



TE Part # 91515-1  
CCII TYPE III+ MNL PIN SKT 30-20  
ASSY



TE Part # 91519-1  
CCII TYPE III+ PIN SKT 18-14 ASSY



TE Part # 91505-1  
CCII TYPE III+ 24-16 ASSY

Also in the Series | AMP CPC



Circular Connector Adapters(7)



Circular Connector Boots & Strain  
Relief(6)

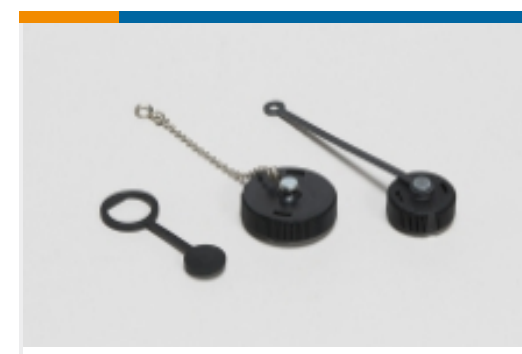

Circular Connector Caps & Covers(16)



Circular Connector Hardware(3)



Circular Connector Keying Plugs(2)



Circular Connector Seals(36)



Circular Power Connectors(467)



Insertion & Extraction Tools(1)

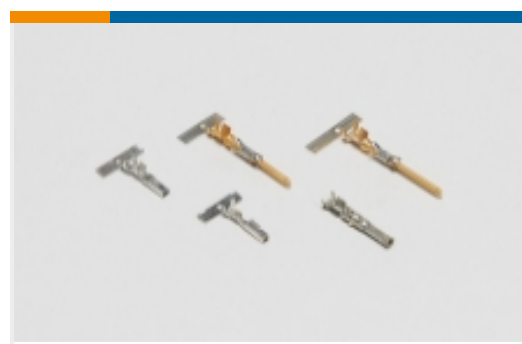

Power Contacts(6)



Sealing Sleeves(2)



Unscreened Circular Connector Backshells &amp; Clamps(5)

## Customers Also Bought

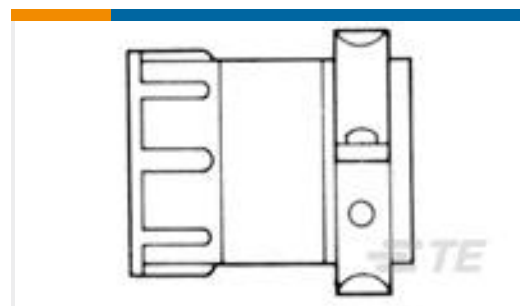
TE Part #206705-4  
CPC RECPT ASSEMBLY SIZE 13-9TE Part #206429-1  
Circular Connector, Environmentally Sealed, CPC Series 6TE Part #206061-1  
RECPT, SZ 11-4, CPCTE Part #206966-9  
CPC Cable ClampsTE Part #206036-1  
RECEPT, SZ 17-16 CPCTE Part #207008-5  
CABLE CLAMP, SIZE 13

## Documents

### Product Drawings

CPC PLUG ASSEMBLY SIZE 13-9

English

### CAD Files

3D PDF

3D

Customer View Model

[ENG\\_CVM\\_CVM\\_206708-1\\_S.2d\\_dxf.zip](#)

English

Customer View Model

[ENG\\_CVM\\_CVM\\_206708-1\\_S.3d\\_igs.zip](#)

English

Customer View Model

[ENG\\_CVM\\_CVM\\_206708-1\\_S.3d\\_stp.zip](#)

English

By downloading the CAD file I accept and agree to the [Terms and Conditions](#) of use.



---

### Datasheets & Catalog Pages

[AMP Circular Connectors for Commercial Signal & Power Applications](#)

English

---

### Product Specifications

[Application Specification](#)

English

---

### Product Environmental Compliance

[MD\\_206708-1\\_021920182242\\_dmtec](#)

English

[MD\\_206708-1\\_021920182242\\_dmtec](#)

English

---

### Instruction Sheets

[Instruction Sheet \(U.S.\)](#)

English

[Instruction Sheet \(U.S.\)](#)

English

---

### Agency Approvals

[UL Report](#)

English