

G3VM: Omron MOSFET relays

Oct, 2018



Relay portfolio

Mechanical Relays

Signal Relays

PCB mechanical Relays for switching current maximum 2A



High-Frequency Relays

High-Frequency relays are suitable for high frequency switching



Power Relays

PCB Relays for high switching capacity



DC Power Relays

DC Power Relays capable of interrupting High-voltage, High-current Loads



Solid State Relays

MOSFET Relays(G3VM series)

MOS FET relays are semiconductor relays suitable for analog switching



PCB Mounting SSR

Miniature,PCB Mounting Type SSR



SSR for Control panel

G2R-compatible Solid State Relay



What is MOSFET relay ?

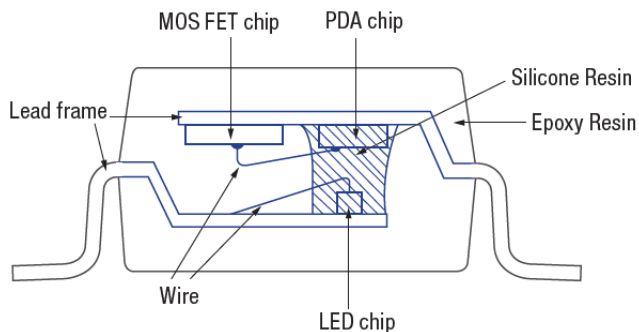
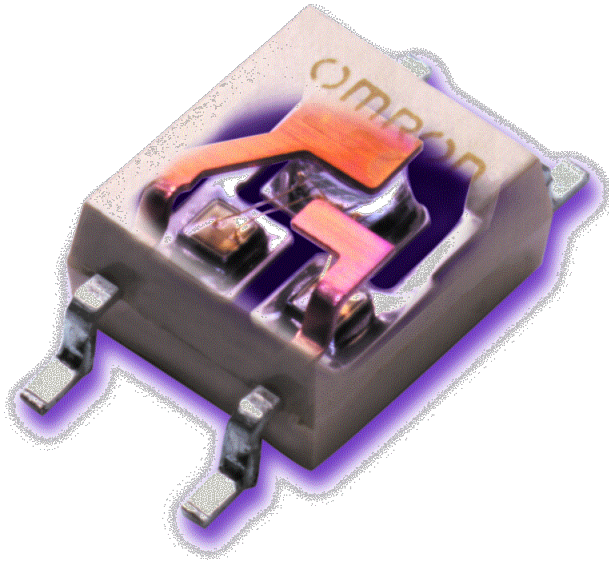

LED: Light Emitting Diode

PDA: Photo Diode Array

MOSFET: Metal-Oxide Field-Effect Transistor

Metal **O**xide **S**emiconductor
Field **E**ffect **T**ransistor

MOSFET RELAYS are semiconductor relays suitable for analogue switching



- Benchmark in SOLID STATE RELAYS
- Features by PHOTOCOUPLER construction
- Employs LED, PDA and pair of Mosfet chip
- Using latest advances in technology, MOSFET relays find still broader usage on market, in new designs a lot of times replacing Reed relays, SSR with either Phototriac or Phototransistor or Photothyristor, and even standard Electromechanical relays

MOSFET Operational Principle

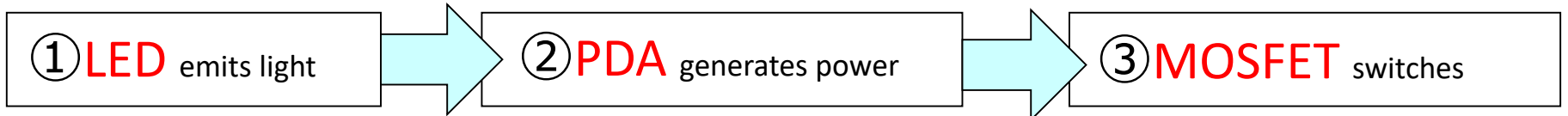
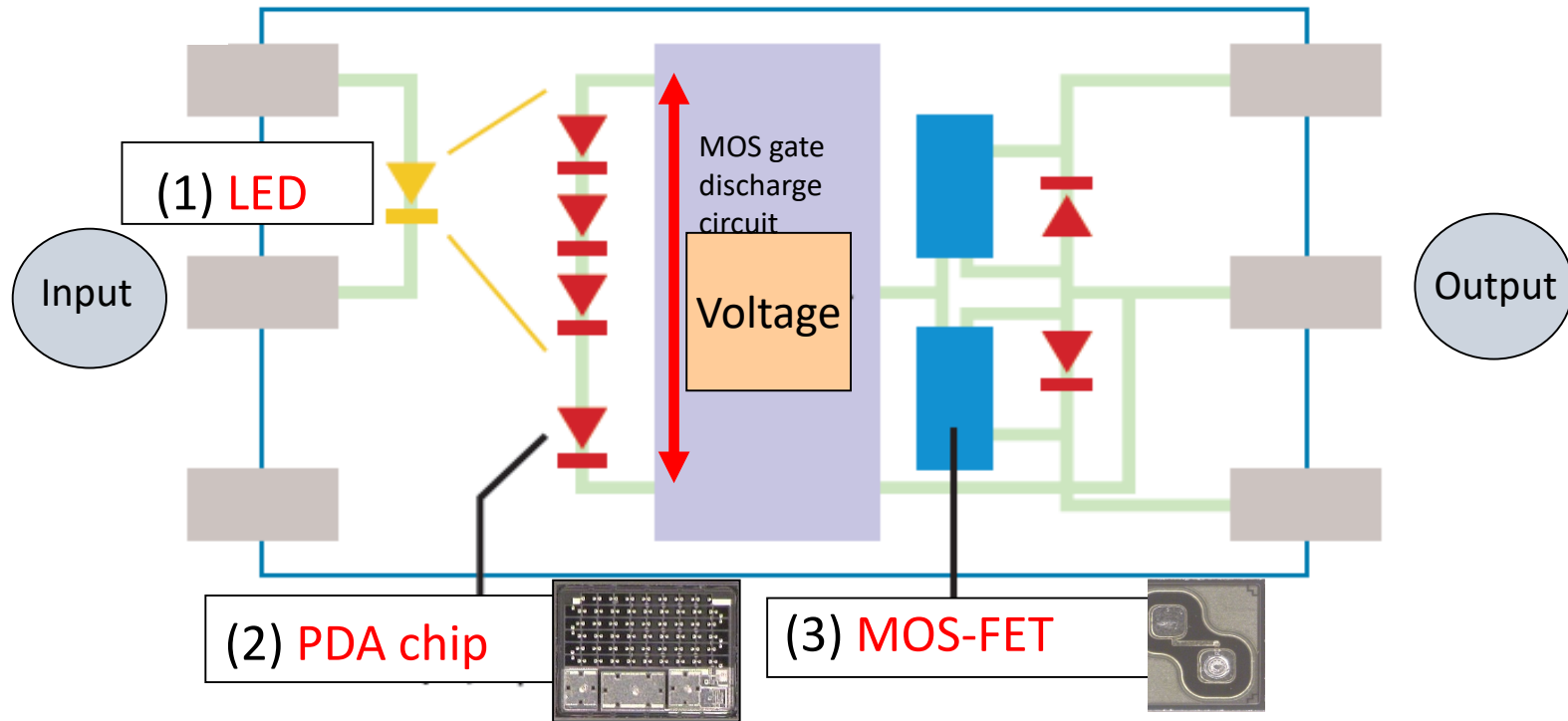
- (1) The LED lights up when the current is connected at the input side.
- (2) The light sent by the LED will be converted into voltage when it is received by the photodiode.
- (3) This voltage will be the gate voltage to drive the MOS FET via control circuit.



Characteristics Comparison of Signal Switching Relays

Technology	Mechanical Relay	Photo coupler	MOSFET relay	Advantage of MOSFET Relay
Parameter				
Life expectancy	General	<i>Excellent</i>	<i>Excellent</i>	✓ Long Operation Life
Switching Speed	General 5ms	<i>Excellent</i>	<i>Good</i> .0.1ms	✓ High Speed Switching
Sound Noise	Bad	<i>Excellent</i>	<i>Excellent</i>	✓ Acoustic noise free
Linearity	<i>Excellent</i>	Bad	<i>Good</i>	
Size Reduction	Bad	<i>Excellent</i>	<i>Excellent</i>	✓ Space saving
Power consumption	Bad 100mW~	<i>Good</i>	<i>Excellent</i> Approx.0.3mW~	✓ Operation power saving
Current leakage	<i>Excellent</i>	Bad	General 20pA~	
Output Capacitance	<i>Excellent</i>	General	General	
Contact resistance (ON resistance)	<i>Good</i> approx.0.1Ω	Bad	<i>Good</i> approx.0.02 to 25Ω	✓ High Energy Efficiency
Off-state Voltage	<i>Excellent</i>	<i>Excellent</i>	<i>Good</i>	
Isolation Voltage	General	General	<i>Good</i>	

MOSFET relays trend

Development Trend

Market Request



Small Size

High current switching

Low CxR

High speed switching

Low power consumption

High Isolation Input / Output

Down sizing of Equipment & Increased Density

Expansion to General application

Replacement of Reed relay

Speed-up of Inspection Time

Energy Saving

Protect for High surge

Lineup by Package

DIP

Bottom surface
100%

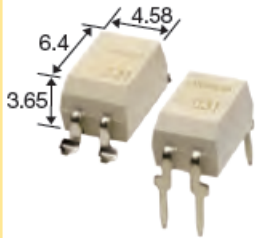

Dual Inline
Package

SOP

Bottom surface
59%

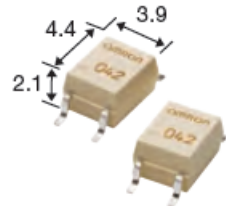

Small
Outline
Package

SSOP

Bottom surface
26%

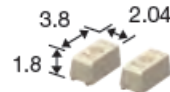

Shrink
Small
Outline
Package

USOP

Bottom surface
21%

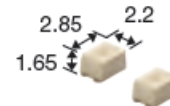

Ultra
Small
Outline
Package

VSON

Bottom surface
12%



Very
Small
Outline
Non-lead

S-VSON

Bottom surface
10%

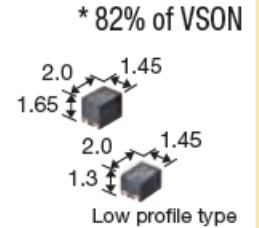

Super
Very
Small
Outline
Non-lead

New

Exception : G3VM-66M

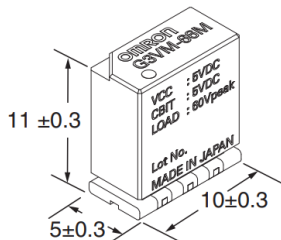

- MOS FET Relay in module package with **SPDT (1C)**
- Contact form 1c (SPDT)
- Surface-mounting, Non-lead
- Operated by voltage (rated input voltage is 5 VDC)



Lineup by Function

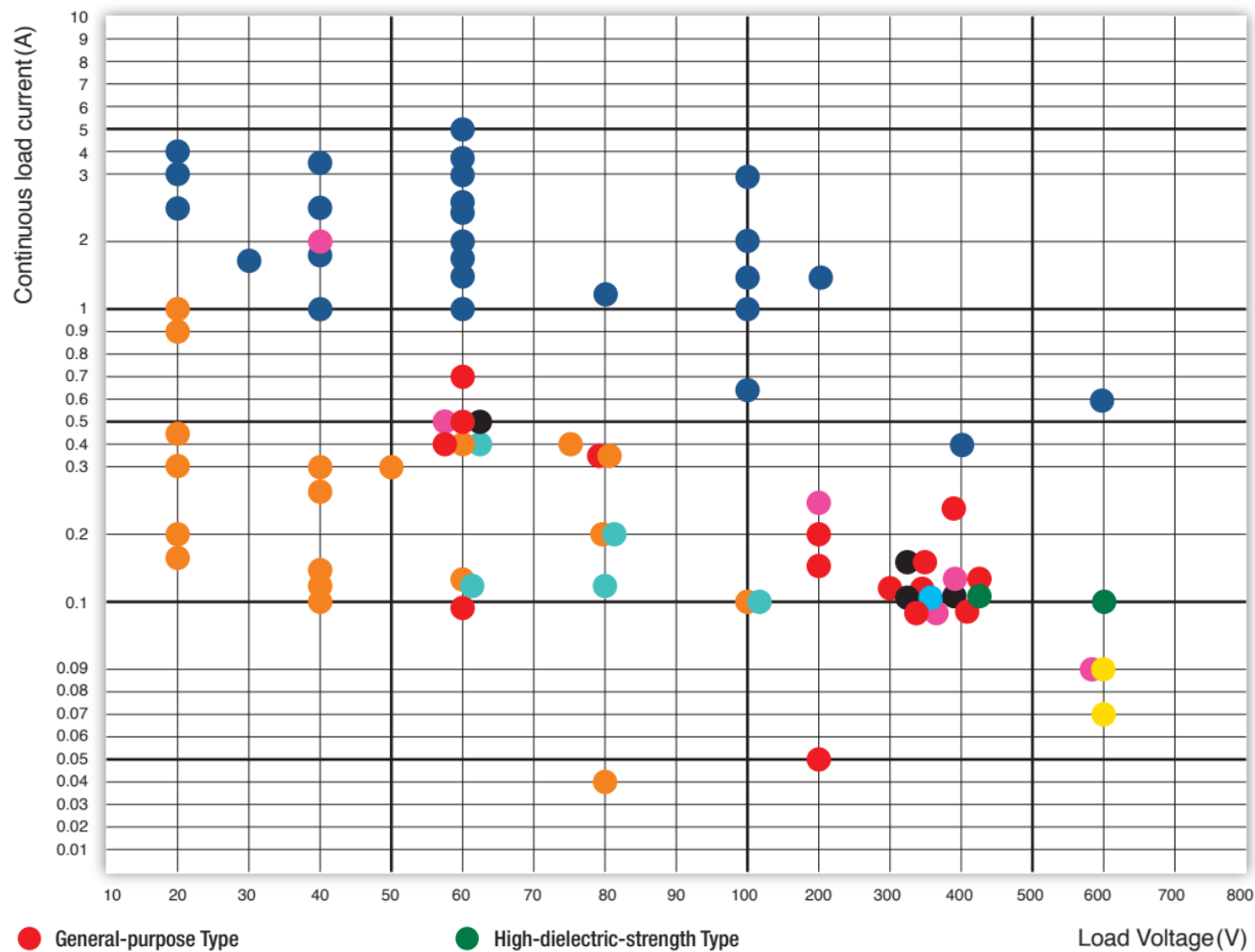

- General-purpose Type
- High-load-voltage Type
- Multi-contact-pair Type (2a, 2b, and 1a1b)
- High-current and Low-ON-resistance Type
- Small and High-dielectric-strength Type
- High-dielectric-strength Type
- Current-limiting Type
- Low-output-capacitance and Low-ON-resistance Type (with Low $C \times R$)
- Small and High-load-voltage Type

Lineup by Package

General Purpose

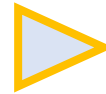

Micro analogue signal switching

High Load Voltage

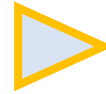

High load voltage switching up to 600V

Multi contact pair

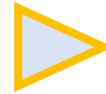

AC/DC load, multiple contact,
2a(DPST-NO), 2b(DPST-NC), 1a1b(SPST-NO
/SPST-NC) for wide range of circuit.

High current and low ON resistance

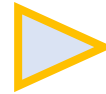

AC/DC load, Low ON resistance in the same level
as mechanical signal relay.

Small and High dielectric strength

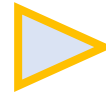

High insulation between input and
output circuit, up to 5kV with DIP4

High dielectric strength

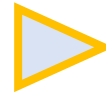

High insulation between input and
output circuit, up to 5kV with DIP6

Current limiting

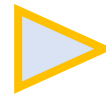

Protect MOSFET itself from overcurrent with a
current limiting protection function

Low output capacitance and Low ON
Resistance

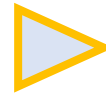

Low Capacitance between terminals + Low Output
ON resistance

Small and High load voltage

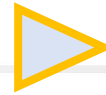

High load voltage up to 600V with small package

Product catalogue

http://omronfs.omron.com/en_US/ecb/products/pdf/en-mos_g_c.pdf

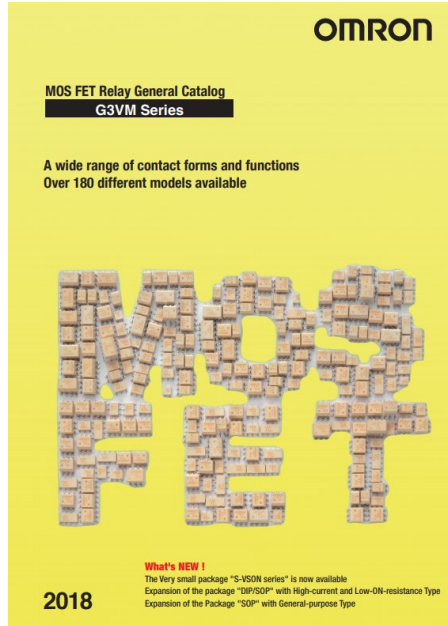

■DIP (Dual Inline Package)

Load Voltage (V) Max.	Model	Number of terminals	Contact form	Continuous load current (mA) Max.	Maximum resistance with output ON (Ohm) Typ.
-----------------------	-------	---------------------	--------------	-----------------------------------	--

■SOP (Small Outline Package)

Load Voltage (V) Max.	Model	Number of terminals	Contact form	Continuous load current (mA) Max.	Maximum resistance with output ON (Ohm) Typ.
20	G3VM-21GR	4	1a	160	5 000

■SSOP (Shrink Small Outline Package)

Load Voltage (V) Max.	Model	Number of terminals	Contact form	Continuous load current (mA) Max.	Maximum resistance with output ON (Ohm) Typ.
20	G3VM-21LR	4	1a	160	
20	G3VM-21LR10	4	1a	200	
20	G3VM-21LR1	4	1a	450	

■USOP (Ultra Small Outline Package)

Load Voltage (V) Max.	Model	Number of terminals	Contact form	Continuous load current (mA) Max.	Maximum resistance with output ON (Ohm) Typ.
20	G3VM-21PR10	4	1a	200	3
20	G3VM-21PR1	4	1a	450	0.6
20	G3VM-21PR11	4	1a	900	0.18

■VSON (Very Small Outline Package Non-leded)

Load Voltage (V) Max.	Model	Number of terminals	Contact form	Continuous load current (mA) Max.	Maximum resistance with output ON (Ohm) Typ.
20	G3VM-21UR10	4	1a	200	3
	3VM-21UR1	4	1a	450	0.8
	3VM-21UR11	4	1a	1000	0.18
	3VM-41UR12	4	1a	100	15
	3VM-41UR10	4	1a	120	12
	3VM-41UR11	4	1a	140	7
	3VM-51UR	4	1a	300	1
	3VM-61UR1	4	1a	120	10

■S-VSON (Super-Very Small Outline Package Non-leded)

Load Voltage (V) Max.	Model	Number of terminals	Contact form	Continuous load current (mA) Max.	Maximum resistance with output ON (Ohm) Typ.	Current leakage when the relay is open (nA) Max.
30	G3VM-31QR <i>NEW</i>	4	1a	1500	0.1	1
40	G3VM-41QR10 <i>NEW</i>	4	1a	120	11	1
60	G3VM-61QR <i>NEW</i>	4	1a	400	1.1	1
60	G3VM-61QR2 <i>NEW</i>	4	1a	1000	0.2	1
100	G3VM-101QR1 <i>NEW</i>	4	1a	650	0.4	1

Applications

Security Equipment

- Smoke detector/Home security panel/PIR/
Video intercom systems



Function	Features	Recommended products
Status output Signal output	General purpose	G3VM-61VY3 G3VM-351VY
	Ultrasensitive	G3VM-61G2
	1b (SPST-NC)	G3VM-63G G3VM-353G
Switching power supply of small solenoid valve, small light External output	High current	G3VM-61VR G3VM-61CR1/FR1 G3VM-201CR/FR G3VM-601CR/FR
	High dielectric strength	G3VM-61AY1/DY1 G3VM-351AY1/DY1

Applications

FA/Industrial Equipment

- Machine tool/Customized power supply/Factory automation (PLC/Thermostat/Timer)
Servo amplifier

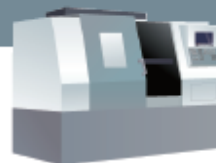

Function	Features	Recommended products
Status output Signal output	General purpose	G3VM-61VY3 G3VM-61A1/D1 G3VM-351VY G3VM-351A/D
Switching power supply of small solenoid valve, small light External output	High current	G3VM-61VR G3VM-61CR1/FR1 G3VM-201CR/FR G3VM-601CR/FR
	High dielectric strength	G3VM-61AY1/DY1 G3VM-351AY1/DY1

Applications

Test & Measurement Equipment



- Semi-conductor test equipment (ATE)/
Semi-conductor test equipment Interface board/
Tester for cars/PXI module/Data logger/ I/O board



Function	Features	Recommended products
Switching test signal	Low C x R	G3VM-21UR1/UR10/UR11 G3VM-41UR10/UR11/UR12 G3VM-41QR10 G3VM-51UR G3VM-61QR
	Small and High-load-voltage	G3VM-61UR1
	High current	G3VM-31QR
	Multi contact pair	G3VM-66M
Switching power supply	High current	G3VM-31QR G3VM-61QR2 G3VM-101QR1

Applications

Communication Equipment

- Modems, Fax machines, network devices, and PBX transfer devices



Function	Features	Recommended products
Short-circuit line switching	General Purpose	G3VM-61VY3 G3VM-351VY
Line switching	1b (SPST-NC)	G3VM-63G G3VM-353G

Applications

Energy-related Equipment

- BMS's (business management systems), power meters, smart meters, secondary power supplies, and photovoltaic systems



Function	Features	Recommended products
External communications Charge voltage monitoring	High dielectric strength	G3VM-61AY1/DY1 G3VM-351AY1/DY1 G3VM-601AY1/DY1
Storage battery charging	General purpose	G3VM-61VY3 G3VM-351VY
	High current	G3VM-61CR1/FR1

Applications

Amusement/Payment Equipment

- Currency Sensing Modules
Coin dispenser / Information system



Function	Features	Recommended products
Status output Signal output	General purpose	G3VM-61VY3 G3VM-351VY
	1b (SPST-NC)	G3VM-63G G3VM-353G

Applications

Energy management

- Smart meter



Function	Features	Recommended products
Switching External, internal signal	High dielectric strength	G3VM-401BY/EY G3VM-601BY/EY

Medical

- Ultra sounds curing instruments,
Low frequency electric therapy equipment,
MRI, Dialyzers for switching prove signal,
Power supply circuit.





End
Of
File